

TECO: a designer's insight into all-electric melting

THIS ARTICLE TAKES A LOOK AT THE PROS AND CONS OF ELECTRIC MELTERS USING JOULE-HEATING. IT DEALS WITH MELTERS WITH ELECTRODES POSITIONED TO PROVIDE SYMMETRICAL ENERGY RELEASE. THE ARTICLE ALSO DISCUSSES THE ATTRIBUTES OF COLD-TOP MELTING AND ITS INHERENT EMISSIONS CONTROL CHARACTERISTICS. ALL-ELECTRIC FOREHEARTH AND CHANNELS ARE ALSO LOOKED INTO. PRODUCTION COST SCENARIOS ARE PROVIDED FOR COMPARISON BY FUEL TYPE AND LOCATION.

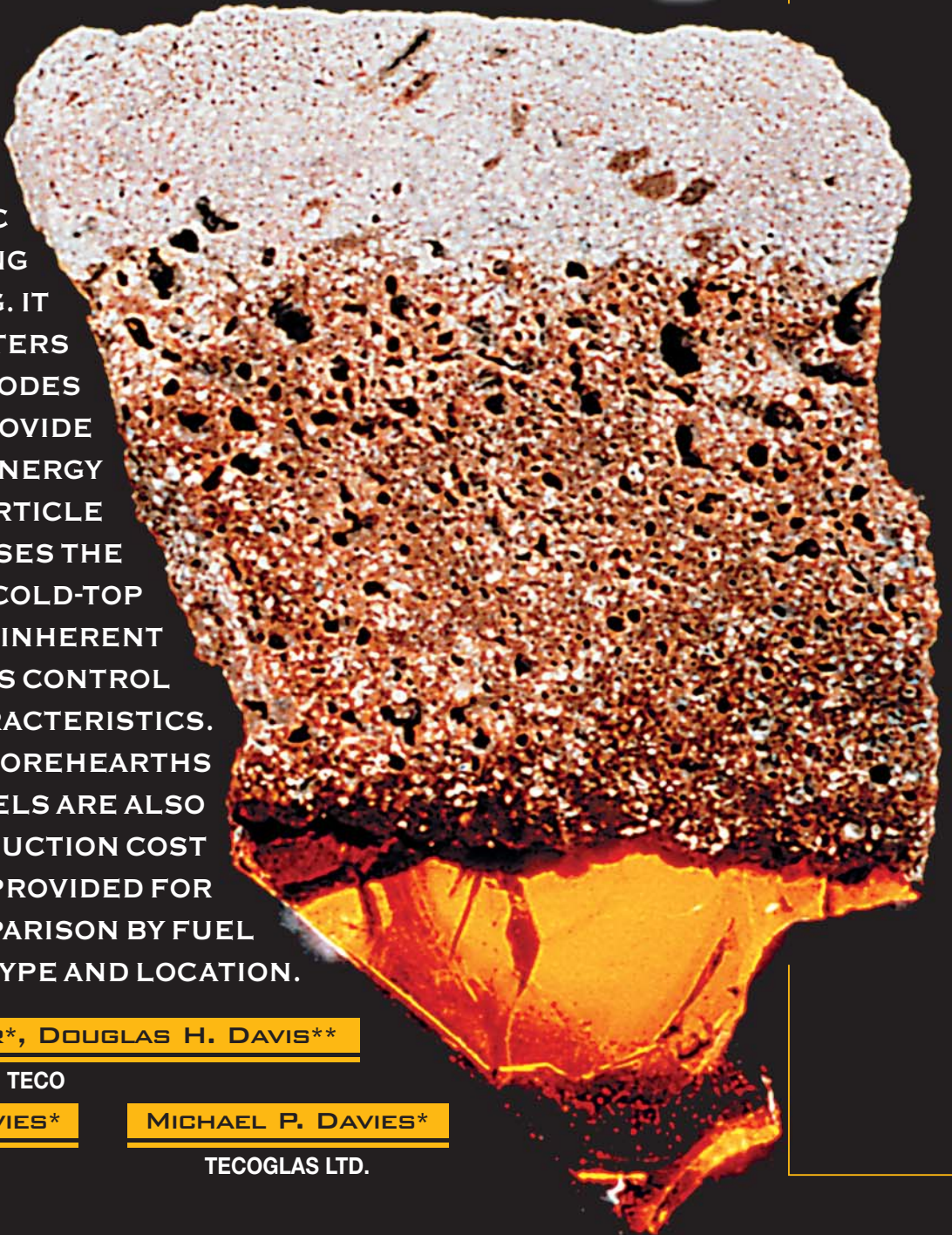

CARL W. HIBSCHER*, DOUGLAS H. DAVIS**

TECO

PETER R.H. DAVIES*

KTGSI

MICHAEL P. DAVIES*

TECOGLAS LTD.



A Cold-Top All-Electric Melter

INTRODUCTION

Fire and glass are inextricably bound, per the motto of the National Fraternity of ceramic Engineers, “through Fire to Perfection”. Yet, an obscure glass property, electrical conductivity, has developed into an important commercial technology, i.e., melting glass with electricity. Glass that melts itself without fire. Magic indeed!

Voelker’s 1902 patents claimed feasibility, but little electric melting was done until the 1950s, when pioneers showed that molybdenum electrodes lasted for extended periods in many glass types, without colouring the glass. Initial developments were in the borosilicate and lead glass industries, both industries with serious emission problems. Glass fibre became a major producer in these all-electric melters.

For this article, we narrowly define “Electric Melter” as one that uses only electricity to heat glass, via Joule-heating. We will not cover electric boosting of fossil fuel melters. This precise delivery of localized energy has seen widespread adoption, and the TECO group has supplied many boost systems. There are other all-electric systems, such as induction, DC arc, plasma, or even microwave melting, which do not currently significantly influence the glass industry.

TYPES OF ALL-ELECTRIC MELTERS

The majority of the successful all-electric melters can be broken

into two categories. The most common, which can be designated as “Uniform Melters”, have electrodes positioned and sized to provide reasonably uniform, symmetrical energy release, minimizing hot spots and convective flows from uneven heating. Most, but not all of these, are cold-tops (as shown here), with a complete layer of raw batch insulating the surface. A flux-line diagram of a single square metre of this type with three vertical electrodes in each corner would indicate a reasonably uniform heat release in the glass, especially with vertical electrodes. Of course, the energy release will certainly be more concentrated at the electrodes, and, in fact, math models of these furnaces confirm that there is still considerable flow in these

melters. Therefore, the term “uniform melter” best refers to the approach, not the end result.

These melters use molybdenum (Mo) or tin oxide (SnO_2) electrodes, depending mainly on the oxidation state of the glass. Tin oxide is suitable for oxidizing conditions, but its relatively low melting point restricts its use. It is either directly cooled or carefully placed to avoid peak glass temperatures.

SnO_2 is used as massive stubs in the wall or bottom, or as wall sections of stacked blocks so that current density will be low and the SnO_2 can be directly cooled from the back. Tin oxide is used by the author’s group almost exclusively in lead glass melters, where raw materials require oxidation.

Molybdenum, on the other hand, is rigid at high temperatures, but must be protected from oxidation. The high temperature strength of molybdenum allows it to be used as multiples of relatively small diameter rods, with long immersions to give high surface area; minimizing temperatures immediately around the electrode.



High surface
area
molybdenum
electrodes
for uniform
melters

Vertical, bottom-entry, or horizontal side-entry Mo electrodes are both used in cold-top melters; allowing flexibility in locating electrodes so as to give symmetrical, reasonably uniform energy release in the glass. The high surface area also allows higher energy input without high current densities that reduce electrode life and give hot spots. Improved electrode holders, using water-cooling for glass sealing and, depending on the glass seal expected, inert gas flushing in the holder, make the use of bottom rods practical. These new style holders permit periodic, safe, electrode advancement, or even replacement on the run. Electrode diameters up to four inches maximize campaign life. These uniform, cold top melters traditionally have only required collection of dust from the charging operation.

Platinum is used only for very special applications due to its cost.

Another type of all-electric melter is the Intensive Melter, where energy release is purposely concentrated in a small area, generating high temperatures and strong convective flows. These are related to the Pouchet-type melter, although the degree of energy concentration varies. These melters have been used for textile glass and in some insulating fibreglass facilities where their small size, low initial capital, and short rebuild times make their relatively high energy cost per ton of glass and short campaign life acceptable. High temperatures and intense flows assist in homogenization and dissolution, although they have short residence times. In most cases, they will require emission control, partly from charging dust, but also for volatilization of boron oxide et.al. from the extremely hot glass at the exit, and from the surface, depending on the condition of the batch crust.

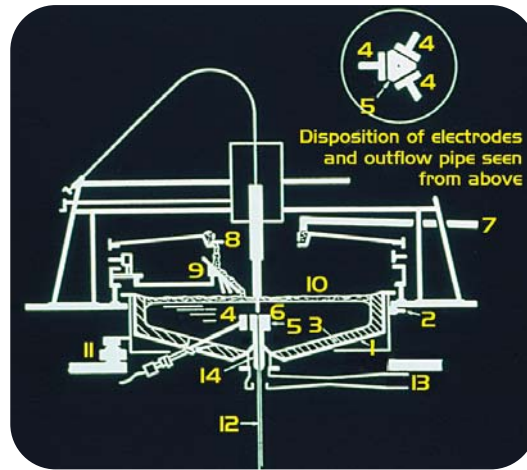

Intensive Melter

In more recent years, energy preference has shifted away from electricity, largely due to new availability of low cost gas and oil and volatility of the electric markets. More recently, with the decreasing cost of oxygen generation, oxy-fuel melting has become an attractive alternative to electric melting. As a result, from 1980 to the present, we have only built about 20 new electric melters. However, they are on the list we help clients choose from, and we expect to build more all-electrics - if the conditions are right for our clients.

BENEFITS OF ELECTRIC MELTERS

In spite of relatively high electric costs in most areas, an electric melter uses that energy very efficiently. Heat is generated within the glass and is well-insulated by the batch blanket over the melt. Soda-lime and sodium borate glasses can be produced in an all-electric melter for 780-800 kWh/ton (2.5-2.7 MMBtu/ton), about half that commonly used on air/gas melters. This equates to roughly 80 per cent fuel efficiency.

The cold-top batch cover, of course, also minimizes emissions.

ELECTRIC MELTER UPS AND DOWNS

As discussed above, in addition to lead glass applications, the borosilicate glasses and, more specifically, fibreglass, have become a major market for electric melters, due to a need to reduce boron emissions. Further impetus was added in the 1970s, when natural gas and oil prices were rising, with no end in sight, due to reported dwindling gas sources. During that period, electric power was more stable, especially in the United States, with abundant coal and availability of nuclear power. The efficiency of direct Joule-heating melting, lower capital for similar tonnage, with low emissions, made electric melting a priority for many of our clients. In the 20 years from 1960 to 1980, TECO and its associated companies, *KTGSI* and *TECO-GLAS Ltd.*, built over 100 all-electric melters.

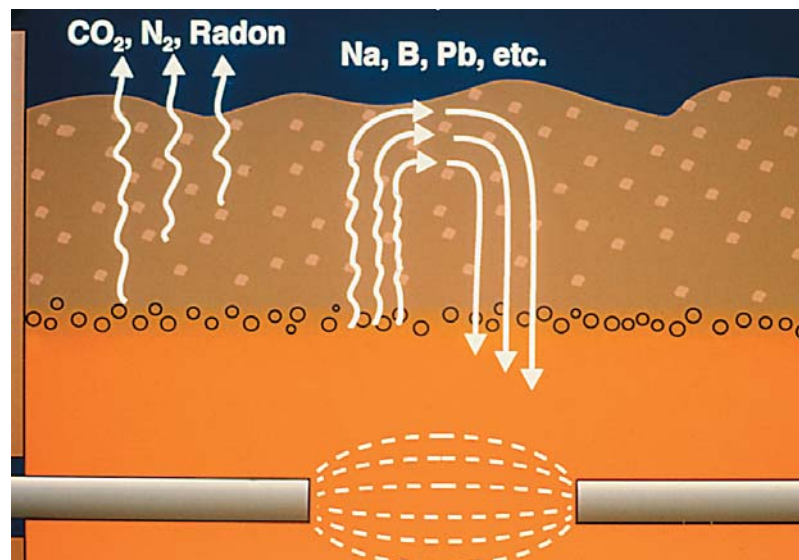

The cold-top batch cover minimizes emission



Electric melter built on the "square pattern"

The sole escape route for batch decomposition gases and volatile species is through this blanket. Species (such as Na_2SO_4) will be condensed within the batch cover and carried down again to the melting interface. As a result, refining agents in a cold-top electric melter only need to be a fraction of those required in a fossil-fuel melter. Cold-top electric melters have been instrumental in reducing emissions from lead glass, and in hazardous waste/radioactive glass melting, where the batch cover retains many dangerous elements volatilized from the glass. In the past, all-electric melting was a complete answer to environmental compliance, except for simple dust control from batch charging. It has recently been necessary to provide more control of particulate and pollutants due to tightening regulations.

If "carbon taxes" become economically significant in efforts against global warming, electric melting could be more cost-effective, making use of untaxed "green" sources of power (hydroelectric, wind, biomass, solar, etc.) may increasingly be a practical and cost-effective glass-melting solution.

Alternate Melters to deliver 70tpd

NEGATIVES OF ELECTRIC MELTERS

Cold-top electric melters are not as simple to operate as fossil fuel. Finding a balance between blanket thickness, batch chemistry, glass temperature, and glass quality require some counter intuitive decisions, plus significant patience. Cold-top melters come with another variable, electrical resistivity, which varies with both temperature and batch chemistry. In electric melters, any change in pull, temperature, etc., must be done in slower, smaller steps than with a fossil-fuel melter. There is a ten-

dency among first-time users of electric melters to excessively "tinker" with the process, making it difficult to ever reach equilibrium.

Cold-top electric melters do not allow for large variations in pull rate. As pull is reduced, glass temperature must also be reduced to maintain the batch blanket, and with lower temperature, at some point, glass quality (refining) will be a problem. Turndown to 50 per cent of nominal would be great, turndown to 75 per cent more likely. Fossil fuel melters have more flexibility.

We mentioned above that "most" of the "uniform" melters

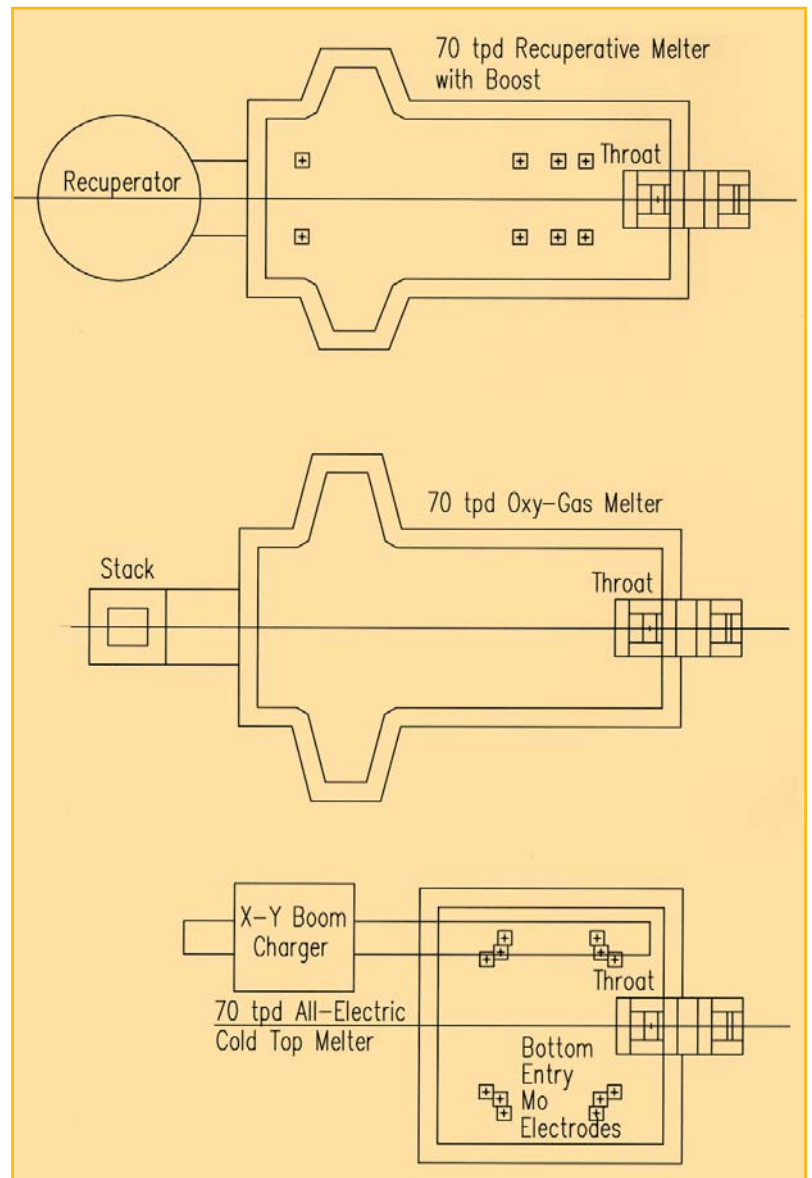

TABLE 1

COMPARATIVE ENERGY PRICES - US DOLLARS

Location	Nat. Gas USD/M scf	Electricity USD/kWh	Oxygen USD/100 scf
US - CALIFORNIA	6.00	0.095	0.215
SPAIN	4.06	0.065	0.185
US - KENTUCKY	5.40	0.040	0.160
QUEBEC - CANADA	8.01	0.036	0.156

are cold-tops. Amber glass is difficult to manage with a cold-top, with serious foam generation. In the retrieved sample shown on the opening page of this article, between the underlying glass and the raw batch, there is a heavy foam that often results from hot spots within the dark glass and reboil sensitivity with some amber batches. It is often necessary to go to partial batch cover with some surface firing.

Very high levels of cullet in the batch can also be a problem in maintaining the batch blanket on a cold-top. It reduces the insulating power of the blanket, providing a window for the escape of infrared technology. High cullet levels from post-consumer sources also increase the odds of redox differences and associated foam.

Glass plant profitability has generally been addressed by increasing melter size, spreading capital costs over more tons of glass. However, all-electric melters seemed to reach a practical maximum at about 300 tons per day. Many electric melters are commonly built on the "square pattern" with bottom entry Mo rods at the corners of the "square". Higher tonnages (up to about 300 tons per day) have been obtained with two "squares" put together with a single central throat. Even higher tonnage by combining more "squares" is logical, but there has not been a demand.

Campaign life of an electric melter is normally less than with a fossil fuel melter, often dictated by throat life. Average refractory temperatures are hotter and convection flows from concentrated heat release close to the electrode accelerates wear. Melter cam-

paign life has improved due to development of new refractories. While earlier soda-lime and sodium borosilicate melters saw roughly two years life, later campaigns using chrome and fused zirconia (AZS) refractories have doubled to about four years.

COMPARABLE ECONOMICS

A client came to us concerning a new 70 metric ton per day melter. The options considered were:

- (1) A gas-air melter with two-stage recuperator and significant boost;
- (2) An oxy-gas unit with no heat recovery and no boost; or
- (3) An all-electric cold-top melter (EMF).

Location is always key, usually defining energy costs.

Table 1 shows four current energy pricing situations in four different locations. The cost of natural gas and electrical power are current and actual. For the cost of oxygen, however, we chose to calculate the rate. The actual cost of oxygen will depend, of course, on the elec-

tricity cost, but also on supply volume, generation mode, local market situation, and vendor competition. For our purposes, we utilized the local power cost and added a "reasonable" mark-up to cover the return on VPSA units to the oxygen vendor for these small applications.

The accumulated cost of energy per ton of glass for the three alternative melter types and four locations is shown in Table 2. With California, pricing for this small melter (left-hand three bars), the cost of natural gas and oxygen (no boost) for the oxy-gas melter should come to roughly USD 39/ton of glass. The recuperative melter with electric boost should cost roughly USD 41/ton for natural gas and electricity. The electric melt furnace (EMF) at the California site requires no natural gas or oxygen, but the cost of electricity alone totals USD 70/ton of glass. Obviously, the EMF is a high cost choice here. In Spain, the oxy-fuel and the recuperative melter are essentially the same. In Quebec, the EMF is clearly the lowest price choice.

A more detailed comparison was developed as shown in Table 3, including capital and operating costs. This covered a 12-year period, so that differing campaign lives and rebuild costs

TABLE 2

ENERGY COST PER TON OF GLASS - 77 TPD

TABLE 3

CAPITAL AND ENERGY OVER 12 YEARS

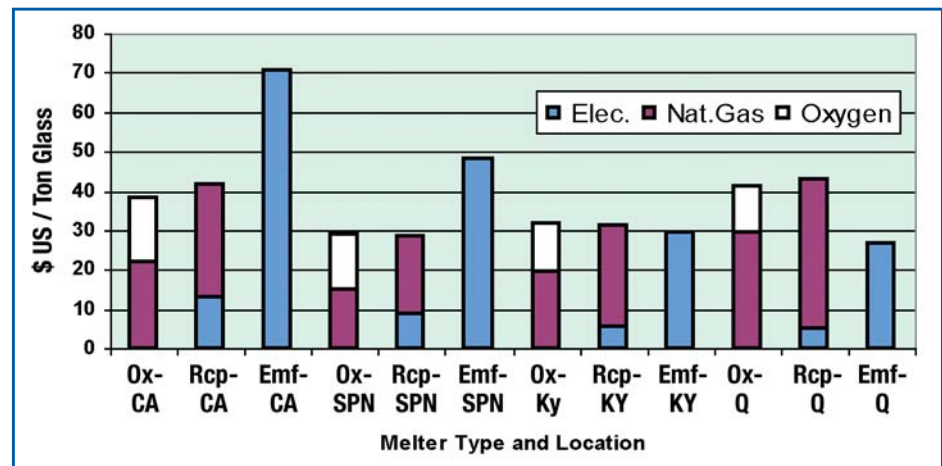
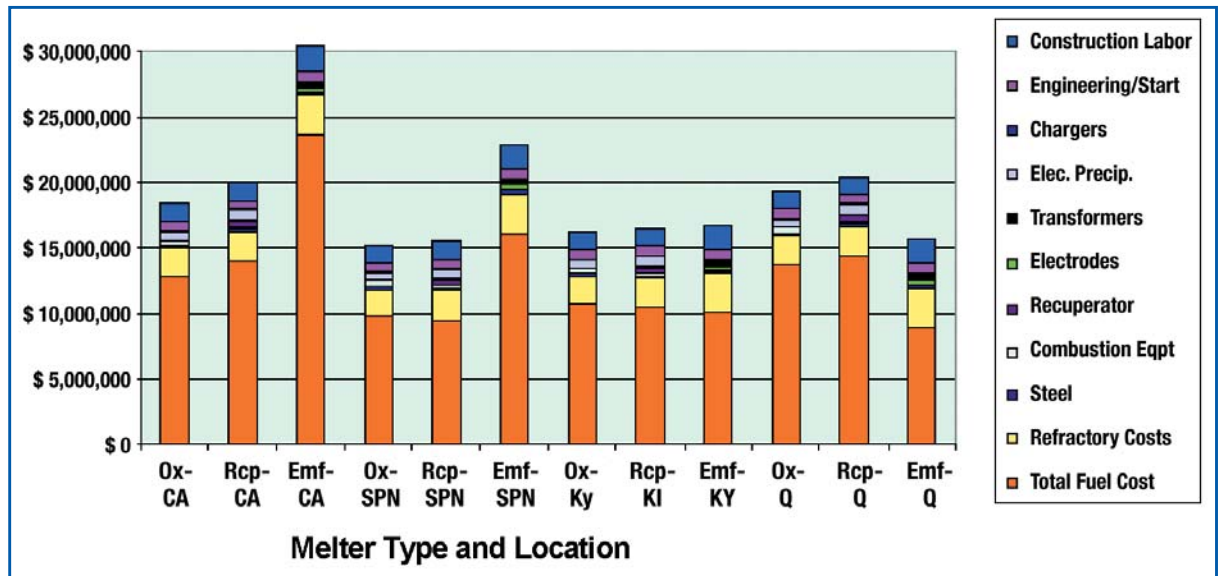

were taken into account. However, the added factors were essentially neutral and implications drawn from energy alone were the same.

ALL-ELECTRIC FOREHEARTH AND CHANNELS

If the local price scenario favours electric melting for the melter, we should consider also using electrical heating for temperature control on the way to the forming operation. The energy cost normally resulting from the

energy required in forehearth and channels can be surprising.

In an E-Glass/continuous fibre operation, there is a substantial length of channels leading into the molten, refined glass to the many individual bushings required to turn the glass into tons of fine fibres. As an example, one E-Glass operation uses 28 MMBtu/hr in its melter, and then, in addition, another 17 MMBtu/hr to control the glass cooling and maintain that temperature for forming. Roughly 40 per cent of the total energy bill is associated with the forehearths and channels.

Of course, the particular arrangement chosen was based on a complex mix of choices, including the size of fibres needed, number of bushings, the total tons of fibre needed, the arrangement of the fibre-forming operations below the melter, the number of furnaces, and more.

Another example is a wool fibreglass plant (C-glass) that has already made the choice of an all-electric

melter. This melter operates at 5,850 kWh/hr, or 20 MMBtu/hr. However, for various reasons, the forehearths transporting the glass to the spinners are fired with natural gas, consuming 15 MMBtu/hr. Putting these on the same energy basis, the forehearth system constitutes 43 per cent of the total energy consumption.

Thus, the energy required for controlling the glass past the melter is significant. If all-electric melting is one of the possibilities for your melter, or even if it is not, you should extend that consideration to the forehearths. The extremely high efficiency of joule-heating can produce overall saving even if electricity is more expensive on a straight energy comparison. All-electric forehearths also eliminate the large volume of combustion gases usually exhausted into the plant environment. While the low-temperature combustion does not generate significant amounts of NOx, both the heat and the gases are less than desirable.

Most of the glass industry applications can be carried out using all-electric heating. All-electric forehearths have taken several approaches. In most cases,

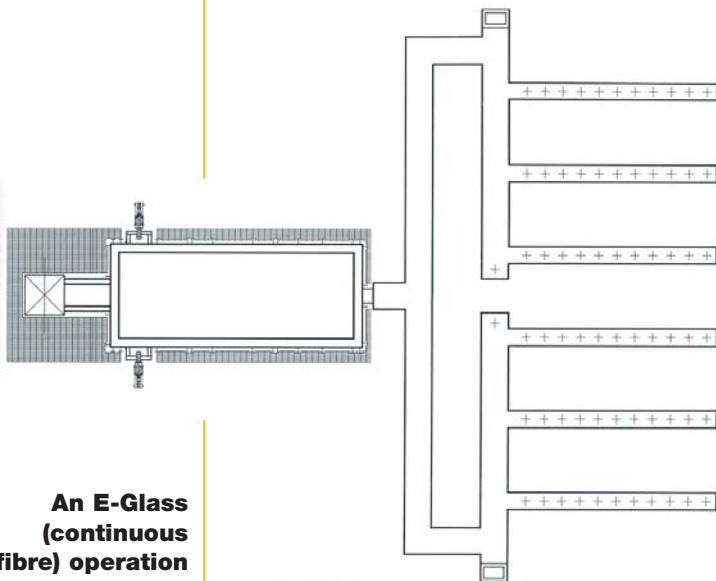

An E-Glass (continuous fibre) operation

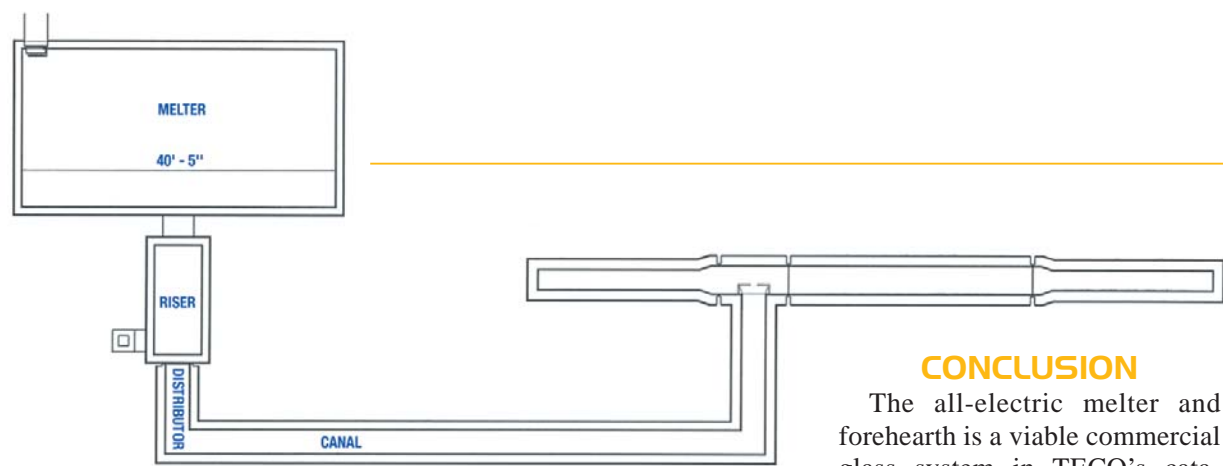

CONCLUSION

The all-electric melter and forehearth is a viable commercial glass system in TECO's catalogue. Currently, due to the cost of electricity and new alternatives such as oxy/fuel firing, the use of all-electric melters has declined. However, given the right pricing situation, they can be the correct tool.

PUBLISHED WITH THE PERMISSION OF THE AMERICAN CERAMIC SOCIETY, WWW.CERAMICS.ORG. COPYRIGHT. ALL RIGHTS RESERVED.

a major part of the energy is applied from in-glass joule heating with electrodes of various materials being inserted into the glass and a potential applied. The energy is transferred directly to the glass by I^2R heating of the same glass itself.

We do hear concerns that exaggerated heat release at the tip of a worn electrode could result in severe local heating with reboil and attendant bubble defects. This is very uncommon, since the design takes this into account. First, the nominal amperage applied is normally limited to 10 amps/in² or less for a normal reduced soda lime. For glasses with more reboil potential, the surface loading is kept even lower. Secondly, the operators monitors the amps and volt history of the electrodes, which will signal changes in the surface area being used for firing. In most cases, a worn electrode can be advanced further into the glass, or even replaced entirely on-the-fly. In a section of all-electric forehearth, the typical pattern is shown of a single phase firing diagonally across a zone where electrodes directly across from each other are at the same potential. Thus, advancing a

worn electrode does not aggravate an already hot tip, because current passage is side-to-side, and not tip-to-tip between the two electrodes.

Of course, the goal of the forehearth, etc. is not only just to transport glass, but to bring this glass to a uniform desired forming temperature. This is a complex job. Additional electric heat has been used in the superstructure above the channels, via SiC and MoSi₂ radiant elements. These can be used directly between the glass and the refractories, or with highly volatile glasses, with refractory muffle plates covering the glass, still allowing diffused radiant heating. In other cases, electrical elements have been installed within the refractories to slow the loss of heat from the glass, and provide an adjustable control to the effective "insulating power".

Probably the last forehearth situation to be tackled has been the E-glass or other continuous fibre compositions, where the glass has extremely high electrical resistance due to low alkali. We have provided proposals on such systems and are convinced that the all-electric concept would work well.

***ASSISTANT TO THE PRESIDENT**
**** SENIOR GLASS TECHNOLOGIST**
 Teco - USA

***MANAGER - ELECTRIC MELTING TECHNOLOGY**
 KTGSI - USA

***DIRECTOR OF PROJECTS**
 Tecoglas - UK

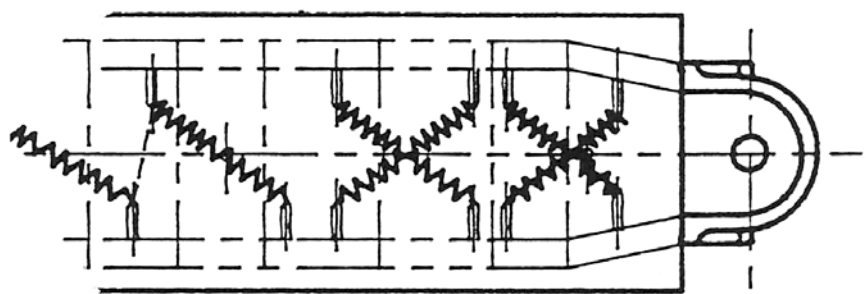

TECO
Toledo Engineering Co., Inc.
 3400 Executive Parkway
 P.O. Box 2927
 Toledo, Ohio 43606-2927
USA
 Tel: +1 - 419 - 5379711
 Fax: +1 - 419 - 5371369
 www.teco.com

All-electric forehearth with single-phase diagonal firing